



This report provided free of charge by:

**Freeman Motor Company Salem**

3784 Portland Rd NE  
Salem, OR 97301

503-987-5001



Customer Favorites



# Vehicle History Report™

US \$44.99

## 2017 JAGUAR F-PACE S

VIN: SADCM2BV6HA488046  
4 DOOR WAGON/SPORT  
UTILITY  
3.0L V6 F DOHC 24V  
GASOLINE  
ALL WHEEL DRIVE

This CARFAX Report Provided  
by:  
**Freeman Motor Company  
Salem**

♥ 5 Customer Favorites

### Damage reported: minor damage

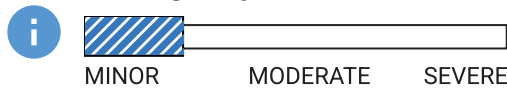

🔧 9 Service history records

1 CARFAX 1-Owner vehicle

🏠 Personal vehicle

📊 65,733 Last reported odometer reading



This CARFAX Vehicle History Report is based only on information supplied to CARFAX and available as of 3/26/25 at 4:04:02 PM (CDT). Other information about this vehicle, including problems, may not have been reported to CARFAX. Use this report as one important tool, along with a vehicle inspection and test drive, to make a better decision about your next used car.



## Accident / Damage History

Not all accidents / issues are reported to CARFAX

### Event 1

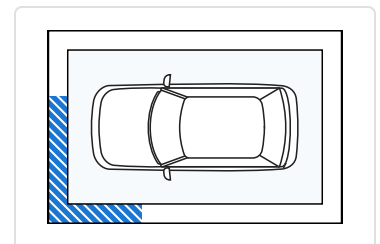
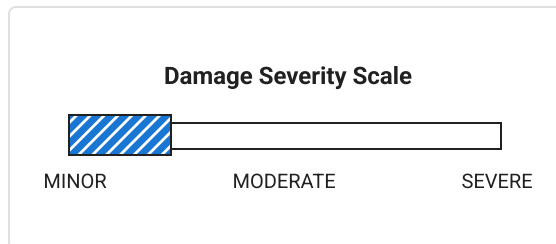

12/12/2023

**Damage reported: minor  
damage**



## CARFAX Recent Service Highlights

Key services performed in the last 12 months

Service	Comments	Date	
 Oil	 Oil and filter changed	01/07/2025	<a href="#">View Details</a> >
		<div style="border: 1px solid #007bff; padding: 5px; border-radius: 5px;">                     This car has been recently serviced. That's a good thing!                 </div>	

## CARFAX Additional History

Not all accidents / issues are reported to CARFAX

**Owner 1**

### Total Loss

No total loss reported to CARFAX.

 No Issues Reported

### Structural Damage

CARFAX recommends that you have this vehicle inspected by a collision repair specialist.

 No Issues Reported

### Airbag Deployment

No airbag deployment reported to CARFAX.

 No Issues Reported

### Odometer Check

No indication of an odometer rollback.

 No Issues Indicated

### Accident / Damage

Damage reported: 12/12/2023.

Minor Damage

### Manufacturer Recall

No open recalls reported to CARFAX.

 No Recalls Reported

### Basic Warranty

Original warranty estimated to have expired.

**Warranty Expired**

## CARFAX Title History

CARFAX guarantees the information in this section

**Owner 1**

### Damage Brands

Salvage | Junk | Rebuilt | Fire | Flood | Hail | Lemon

 **Guaranteed**  
No Problem

### Odometer Brands

Not Actual Mileage | Exceeds Mechanical Limits

 **Guaranteed**  
No Problem







**GUARANTEED** - None of these title problems were reported by a U.S. state Department of Motor Vehicles (DMV). If you find that any of these title problems were reported by a DMV and not included in this report, you may qualify.  
View Terms | View Certificate

<b>CARFAX</b> Ownership History		Owner 1
The number of owners is estimated		
Year purchased		2017
Type of owner		Personal
Estimated length of ownership	<b>CARFAX</b> <b>1 OWNER</b>	8 yrs. 2 mo.
Owned in the following states/provinces		Washington
Estimated miles driven per year		8,199/yr
Last reported odometer reading		65,733

<b>CARFAX</b> Detailed History			
	<b>Owner 1</b> Purchased: 2017		<div style="border: 1px solid blue; padding: 5px;"> <b>Low mileage!</b> This owner drove less than the industry average of 15,000 miles per year.                 </div> Personal Vehicle 8,199 mi/yr
Date	Mileage	Source	Comments
01/03/2017		Washington Motor Vehicle Dept. Port Ludlow, WA Title #1708455842	<b>Title issued or updated</b> - First owner reported - Titled or registered as personal vehicle - Loan or lien reported - Vehicle color noted as Gold
01/10/2017	12	Rusnak/Pasadena Jaguar Pasadena, CA 626-449-0770 jaguar.rusnakonline.com ★ 4.9 / 5.0 8 Verified Reviews	<b>Vehicle serviced</b> - Pre-delivery inspection completed - Tire condition and pressure checked
01/17/2017		Washington Motor Vehicle Dept. Port Ludlow, WA Title #1712858046	<b>Title issued or updated</b> - Correction to record - Duplicate title issued - Loan or lien reported - Vehicle color noted as Gold
12/14/2017		Washington Motor Vehicle Dept.	<b>Registration issued or renewed</b> - Vehicle color noted as Gold

Port Ludlow, WA  
Title #1712858046

03/22/2018	10,507	Jaguar Land Rover Volvo of Tacoma Fife, WA 253-922-7878 jaguaroftacoma.com ★ 4.3 / 5.0 119 Verified Reviews ♥ 3,154 Customer Favorites		<b>Vehicle serviced</b> - Wipers/washers checked - Wiper(s) replaced
06/11/2018		Washington Motor Vehicle Dept. Port Ludlow, WA Title #1739923712		<b>Title issued or updated</b> - Correction to record - Duplicate title issued - Vehicle color noted as Gold
12/12/2018		Washington Motor Vehicle Dept. Port Ludlow, WA Title #1739923712		<b>Registration issued or renewed</b> - Vehicle color noted as Gold
01/14/2019	16,113	Jaguar Land Rover Volvo of Tacoma Fife, WA 253-922-7878 jaguaroftacoma.com/ ★ 4.3 / 5.0 119 Verified Reviews ♥ 3,154 Customer Favorites		<b>Vehicle serviced</b> - Maintenance inspection completed - Recommended maintenance performed - Oil and filter changed
12/04/2019	23,094	Jaguar Land Rover Volvo of Tacoma Fife, WA 253-922-7878 jaguaroftacoma.com/ ★ 4.3 / 5.0 119 Verified Reviews ♥ 3,154 Customer Favorites		<b>Vehicle serviced</b> - Brake fluid flushed/changed - Brakes serviced - Oil and filter changed
02/12/2020		Washington Motor Vehicle Dept. Port Ludlow, WA Title #1739923712		<b>Registration issued or renewed</b> - Vehicle color noted as Gold
12/04/2020	29,077	Jaguar Land Rover Volvo of Tacoma Fife, WA 253-922-7878 jaguaroftacoma.com/ ★ 4.3 / 5.0 119 Verified Reviews		<b>Vehicle serviced</b> - Maintenance inspection completed - Maintenance reminder reset - Oil and filter changed

♥ 3,154 Customer Favorites

12/16/2020	Washington Motor Vehicle Dept. Port Ludlow, WA Title #1739923712	<b>Registration issued or renewed</b> - Vehicle color noted as Gold
------------	---	--

11/29/2021	Washington Motor Vehicle Dept. Port Ludlow, WA Title #1739923712	<b>Registration issued or renewed</b> - Vehicle color noted as Gold
------------	---	--

12/18/2021	39,628	Jaguar Land Rover Volvo of Tacoma Fife, WA 253-922-7878 jaguaroftacoma.com/ ★ 4.3 / 5.0 119 Verified Reviews ♥ 3,154 Customer Favorites	🔧 <b>Vehicle serviced</b> - Maintenance inspection completed - Maintenance reminder reset - Rear brakes replaced - Tire condition and pressure checked
------------	--------	---	--

01/07/2023	Washington Motor Vehicle Dept. Port Ludlow, WA Title #1739923712	<b>Registration issued or renewed</b> - Vehicle color noted as Gold
------------	---	--

03/16/2023	50,148	Jaguar Land Rover Volvo of Tacoma Fife, WA 253-922-7878 jaguaroftacoma.com/ ★ 4.3 / 5.0 119 Verified Reviews ♥ 3,154 Customer Favorites	🔧 <b>Vehicle serviced</b> - Maintenance inspection completed - Recommended maintenance performed - Maintenance reminder reset - Vehicle washed/detailed
------------	--------	---	---

12/11/2023	Washington Motor Vehicle Dept. Port Ludlow, WA Title #1739923712	<b>Registration issued or renewed</b> - Vehicle color noted as Gold
------------	---	--

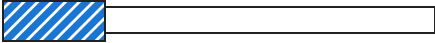
12/12/2023	Damage Report	 <b>Damage reported: minor damage</b> - Damage to front - Damage to left front
<div style="border: 1px solid #ccc; padding: 10px; text-align: center;"> <p><b>Damage Severity Scale</b></p>  <p>MINOR                      MODERATE                      SEVERE</p> </div>		
<div style="border: 1px solid #ccc; padding: 10px; text-align: center;"> <p><b>Damage Location</b></p> </div>		

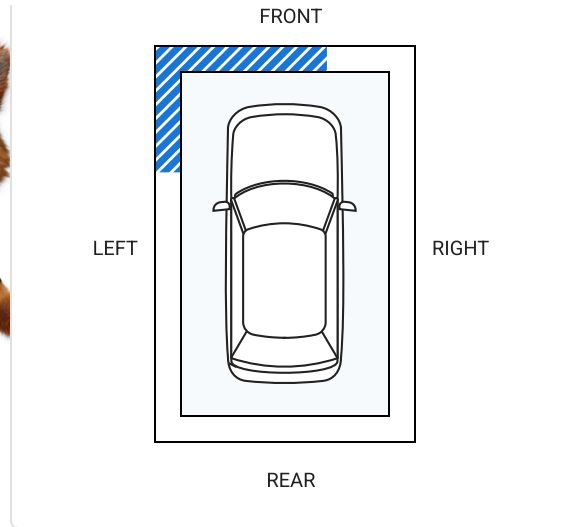

### CARFAX HAS THE MOST ACCIDENT & DAMAGE INFORMATION



Minor damage is usually cosmetic, including dents or scratches to the vehicle body.

01/18/2024 56,776	Jaguar Land Rover Volvo of Tacoma Fife, WA 253-922-7878 jaguaroftacoma.com/		<b>Vehicle serviced</b> - Maintenance inspection completed - Maintenance reminder reset - Oil and filter changed - Wipers/washers checked
	★ 4.3 / 5.0 119 Verified Reviews ❤️ 3,154 Customer Favorites		
01/07/2025 65,733	Jaguar Land Rover Volvo of Tacoma Fife, WA 253-922-7878 jaguaroftacoma.com/		<b>Vehicle serviced</b> - Maintenance inspection completed - 60,000 mile service performed - Brakes serviced - Drive belts checked - Maintenance reminder reset - Oil and filter changed - Vehicle washed/detailed
	★ 4.3 / 5.0 119 Verified Reviews ❤️ 3,154 Customer Favorites		
03/04/2025	Online Listing		<b>Vehicle offered for sale</b>
03/06/2025	Auto Auction		<b>Vehicle sold</b>



Millions of used vehicles are bought and sold at auction every year.

Have Questions? Consumers, please visit our Help Center at [www.carfax.com](http://www.carfax.com). Dealers or Subscribers, please visit our Help Center at [www.carfaxonline.com](http://www.carfaxonline.com).



## Glossary

### Damage Indicator

Damage can be a result of many different types of events. Examples include contact with objects (other cars, trees, traffic signs, road debris, etc), vandalism, or weather-related events. Not every damage event is reported to CARFAX. As details about the damage event become available, those additional details are added to the CARFAX Vehicle History Report. CARFAX recommends that you have this vehicle inspected by a qualified mechanic.

- This CARFAX Vehicle History Report is based only on information supplied to CARFAX and available as of 3/26/25 at 4:04:02 PM (CDT). Other information about this vehicle, including problems, may not have been reported to CARFAX. Use this report as one important tool, along with a vehicle inspection and test drive, to make a better decision about your next used car.

### Damage Severity

Damage events result in one of the following severity levels:

- **Minor:** Generally, minor damage is cosmetic (including dents or scratches), may only require reconditioning, and typically does not compromise a vehicle's operation and/or safety.
- **Moderate:** Moderate damage may affect multiple components of the vehicle and may impair the vehicle's operation and/or safety.
- **Severe:** Severe damage usually affects multiple components of the vehicle and is likely to compromise the vehicle's operation and/or safety.

CARFAX recommends getting a pre-purchase inspection at a certified collision repair facility.

### First Owner

When the first owner(s) obtains a title from a Department of Motor Vehicles as proof of ownership.

### Ownership History

CARFAX defines an owner as an individual or business that possesses and uses a vehicle. Not all title transactions represent changes in ownership. To provide estimated number of owners, CARFAX proprietary technology analyzes all the events in a vehicle history. Estimated ownership is available for vehicles manufactured after 1991 and titled solely in the US including Puerto Rico. Dealers sometimes opt to take ownership of a vehicle and are required to in the following states: Maine, Massachusetts, New Jersey, Ohio, Oklahoma, Pennsylvania and South Dakota. Please consider this as you review a vehicle's estimated ownership history.

### Title Issued

A state issues a title to provide a vehicle owner with proof of ownership. Each title has a unique number. Each title or registration record on a CARFAX report does not necessarily indicate a change in ownership. In Canada, a registration and bill of sale are used as proof of ownership.

Follow Us:  [facebook.com/CARFAX](https://www.facebook.com/CARFAX)

 [@CARFAXinc](https://twitter.com/CARFAXinc)

 [About CARFAX](#)

CARFAX DEPENDS ON ITS SOURCES FOR THE ACCURACY AND RELIABILITY OF ITS INFORMATION. THEREFORE, NO RESPONSIBILITY IS ASSUMED BY CARFAX OR ITS AGENTS FOR ERRORS OR OMISSIONS IN THIS REPORT. CARFAX FURTHER EXPRESSLY DISCLAIMS ALL WARRANTIES, EXPRESS OR IMPLIED, INCLUDING ANY IMPLIED WARRANTIES OF MERCHANTABILITY OR FITNESS FOR A PARTICULAR PURPOSE.

© 2025 CARFAX, Inc., part of S&P Global. All rights reserved.  
3/26/25 4:04:02 PM (CDT)

**I have reviewed and received a copy of the CARFAX Vehicle History Report for this 2017 JAGUAR F-PACE vehicle (VIN: SADC2BV6HA488046), which is based on information supplied to CARFAX and available as of 3/26/25 at 5:04 PM (EDT).**

---

**Customer Signature**

**Date**

---

**Dealer Signature**

**Date**