



This report provided free of charge by:

Freeman Motor Company Salem

3784 Portland Rd NE
Salem, OR 97301

503-987-5001



Customer Favorites



Vehicle History Report™

US \$44.99

2019 MERCEDES-BENZ C-CLASS C 300 4MATIC

VIN: 55SWF8EB9KU289674
SEDAN 4 DR
2.0L I4 F DOHC 16V
GASOLINE
ALL WHEEL DRIVE

This CARFAX Report Provided by:
Freeman Motor Company Salem

♥ 4 Customer Favorites

Accident reported: minor damage

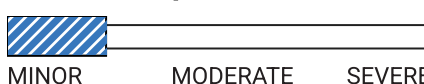

4 Service history records



2 Previous owners



Types of owners: Personal lease, Personal



42,180 Last reported odometer reading



This CARFAX Vehicle History Report is based only on information supplied to CARFAX and available as of 3/22/25 at 6:08:32 PM (CDT). Other information about this vehicle, including problems, may not have been reported to CARFAX. Use this report as one important tool, along with a vehicle inspection and test drive, to make a better decision about your next used car.



Accident / Damage History

Not all accidents / issues are reported to CARFAX

Event 1

10/17/2020

Damage reported: minor damage

Damage Severity Scale

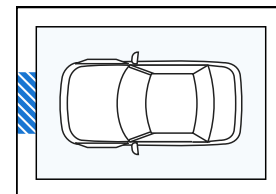
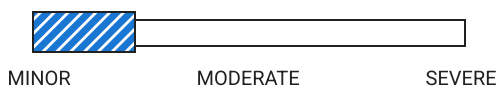

Event 2

05/04/2023

**Accident reported:
minor damage**
- Airbags did not deploy

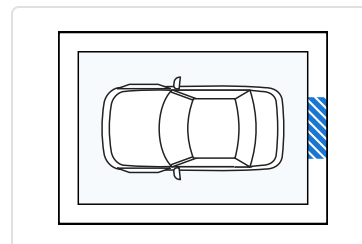
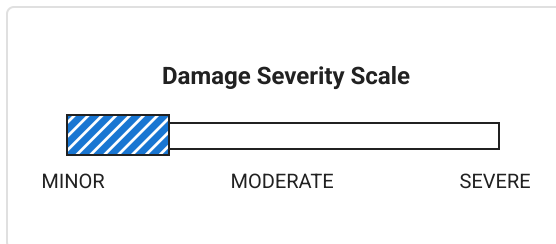

CARFAX Recent Service Highlights

Key services performed in the last 12 months

Service	Comments	Date	
Oil	✓ Oil and filter changed	03/03/2025	View Details >
 <div style="border: 1px solid blue; padding: 5px; display: inline-block;"> This car has been recently serviced. That's a good thing! </div>			

CARFAX Additional History

Not all accidents / issues are reported to CARFAX





	Owner 1	Owner 2
Total Loss No total loss reported to CARFAX.	✓ No Issues Reported	✓ No Issues Reported
Structural Damage CARFAX recommends that you have this vehicle inspected by a collision repair specialist.	✓ No Issues Reported	✓ No Issues Reported
Airbag Deployment No airbag deployment reported to CARFAX.	✓ No Issues Reported	✓ No Issues Reported
Odometer Check No indication of an odometer rollback.	✓ No Issues Indicated	✓ No Issues Indicated
Accident / Damage Damage reported: 10/17/2020. Accident reported: 05/04/2023.	Minor Damage	Minor Damage
Manufacturer Recall No open recalls reported to CARFAX.	✓ No Recalls Reported	✓ No Recalls Reported
Basic Warranty Original warranty estimated to have expired.	Warranty Expired	Warranty Expired

 Title History CARFAX guarantees the information in this section	Owner 1	Owner 2
Damage Brands Salvage Junk Rebuilt Fire Flood Hail Lemon	<input checked="" type="checkbox"/> Guaranteed No Problem	<input checked="" type="checkbox"/> Guaranteed No Problem
Odometer Brands Not Actual Mileage Exceeds Mechanical Limits	<input checked="" type="checkbox"/> Guaranteed No Problem	<input checked="" type="checkbox"/> Guaranteed No Problem



GUARANTEED - None of these title problems were reported by a U.S. state Department of Motor Vehicles (DMV). If you find that any of these title problems were reported by a DMV and not included in this report, you may qualify.
[View Terms](#) | [View Certificate](#)

 Ownership History The number of owners is estimated	Owner 1	Owner 2
Year purchased	2019	2021
Type of owner	Personal lease	Personal
Estimated length of ownership	2 yrs. 10 mo.	3 yrs. 1 mo.
Owned in the following states/provinces	California	California
Estimated miles driven per year	3,753/yr	9,949/yr
Last reported odometer reading	10,548	42,180

 Detailed History			
 Owner 1 Purchased: 2019		<div style="border: 1px solid #00aaff; padding: 5px;"> Low mileage! This owner drove less than the industry average of 15,000 miles per year. </div>	Personal Lease Vehicle 3,753 mi/yr
Date	Mileage	Source	Comments
01/04/2019	8	California Motor Vehicle Dept. San Francisco, CA	Odometer reading reported
01/21/2019		California Motor Vehicle Dept. San Francisco, CA	Title issued or updated - First owner reported - Titled or registered as personal lease vehicle - Loan or lien reported
10/17/2020		Damage Report	 Damage reported: minor damage - Damage to front



CARFAX HAS THE MOST ACCIDENT & DAMAGE INFORMATION

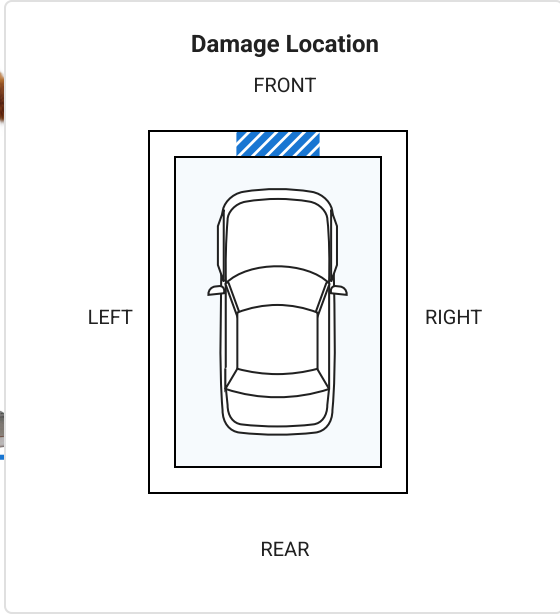
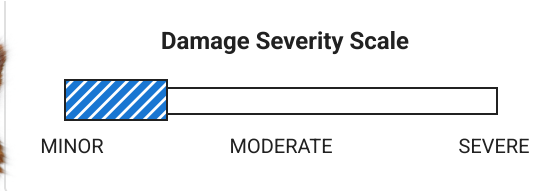

Minor damage is usually cosmetic, including dents or scratches to the vehicle body.

<p>11/11/2021 10,541</p>	<p>Autobahn Motors Belmont, CA</p> <p>★ 4.3 / 5.0 68 Verified Reviews ❤️ 1 Customer Favorite</p>	<p>Vehicle offered for sale</p>
<p>11/12/2021</p>	<p>Mercedes-Benz Dealer Belmont, CA</p>	<p>Vehicle offered for sale</p>
<p>11/22/2021 10,548</p>	<p>Autobahn Motors Belmont, CA 844-896-1944 autobahnmotors.com/</p> <p>★ 4.3 / 5.0 68 Verified Reviews ❤️ 1 Customer Favorite</p>	<p> Vehicle serviced</p> <ul style="list-style-type: none"> - Pre-delivery inspection completed - 30,000 mile service performed - Front license plate bracket installed/replaced - Inside rear view mirror replaced - Vehicle washed/detailed



Looks like this dealer serviced the car in order to prepare it for sale. That's a good thing!

 **Owner 2**

Purchased: 2021



Low mileage! This owner drove less than the industry average of 15,000 miles per year.

Personal Vehicle
9,949 mi/yr

Date	Mileage	Source	Comments
12/13/2021	10,669	California Motor Vehicle Dept. Pacifica, CA	Title issued or updated - New owner reported - Loan or lien reported

05/04/2023		Damage Report	 Accident reported: minor damage - Damage to rear - Airbags did not deploy
------------	--	---------------	--



CARFAX HAS THE MOST ACCIDENT & DAMAGE INFORMATION

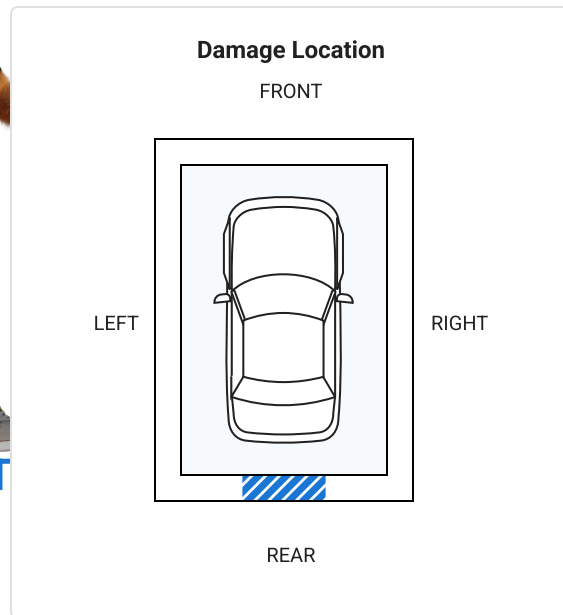
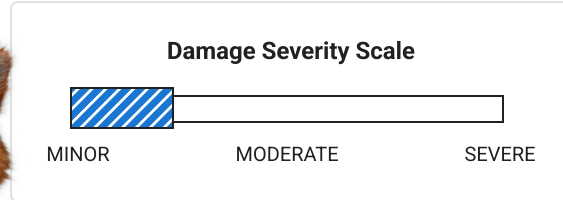

Minor damage is usually cosmetic, including dents or scratches to the vehicle body.



06/22/2023	31,063	Autobahn Motors Belmont, CA 844-896-1944 autobahnmotors.com/	 Vehicle serviced - Engine/powertrain computer/module reprogrammed
		★ 4.3 / 5.0 68 Verified Reviews ❤️ 1 Customer Favorite	

01/30/2024	37,124	Mercedes-Benz of Sacramento Sacramento, CA	 Vehicle serviced - Recommended maintenance performed
------------	--------	---	--

916-924-8000
mbsacramento.com

★ 3.9 / 5.0

268 Verified Reviews

♥ 3,573 Customer Favorites

- Tire condition and pressure checked

02/05/2025	Online Listing	Vehicle offered for sale
02/05/2025	California Motor Vehicle Dept. Pacifica, CA	Title issued or updated - Loan or lien reported
02/11/2025	42,180 Freeman Motor Company Salem Salem, OR 503-485-0007 freemanmotor.com/used-vehicles-portland-or?dealersname=freeman+motor+salem+showroom	Vehicle offered for sale ♥ 4 Customer Favorites
03/03/2025	Freeman Motor Company Portland, OR 503-310-5555 freemanmotor.com ★ 4.6 / 5.0 81 Verified Reviews ♥ 94 Customer Favorites	 Vehicle serviced - Engine/powertrain computer/module checked - Four tires balanced - Four tires mounted - Interior cleaned - Oil and filter changed

Have Questions? Consumers, please visit our Help Center at www.carfax.com. Dealers or Subscribers, please visit our Help Center at www.carfaxonline.com.



Glossary

Accident Indicator

CARFAX receives information about accidents in all 50 states, the District of Columbia and Canada.

Not every accident is reported to CARFAX. As details about the accident become available, those additional details are added to the CARFAX Vehicle History Report. CARFAX recommends that you have this vehicle inspected by a qualified mechanic.

- According to the National Safety Council, Injury Facts, 2021 edition, 5% of the 276 million registered vehicles in the U.S. were involved in an accident in 2019. Over 77% of these were considered minor or moderate.
- This CARFAX Vehicle History Report is based only on information supplied to CARFAX and available as of 3/22/25 at 6:08:32 PM (CDT). Other information about this vehicle, including problems, may not have been reported to CARFAX. Use this report as one important tool, along with a vehicle inspection and test drive, to make a better decision about your next used car.

Damage Indicator

Damage can be a result of many different types of events. Examples include contact with objects (other cars, trees, traffic signs, road debris, etc), vandalism, or weather-related events. Not every damage event is reported to CARFAX.

As details about the damage event become available, those additional details are added to the CARFAX Vehicle History Report. CARFAX recommends that you have this vehicle inspected by a qualified mechanic.

- This CARFAX Vehicle History Report is based only on information supplied to CARFAX and available as of 3/22/25 at 6:08:32 PM (CDT). Other information about this vehicle, including problems, may not have been reported to CARFAX. Use this report as one important tool, along with a vehicle inspection and test drive, to make a better decision about your next used car.

Damage Severity

Damage events result in one of the following severity levels:

- Minor: Generally, minor damage is cosmetic (including dents or scratches), may only require reconditioning, and typically does not compromise a vehicle's operation and/or safety.
- Moderate: Moderate damage may affect multiple components of the vehicle and may impair the vehicle's operation and/or safety.
- Severe: Severe damage usually affects multiple components of the vehicle and is likely to compromise the vehicle's operation and/or safety.

CARFAX recommends getting a pre-purchase inspection at a certified collision repair facility.

First Owner

When the first owner(s) obtains a title from a Department of Motor Vehicles as proof of ownership.

New Owner Reported

When a vehicle is sold to a new owner, the Title must be transferred to the new owner(s) at a Department of Motor Vehicles.

Ownership History

CARFAX defines an owner as an individual or business that possesses and uses a vehicle. Not all title transactions represent changes in ownership. To provide estimated number of owners, CARFAX proprietary technology analyzes all the events in a vehicle history. Estimated ownership is available for vehicles manufactured after 1991 and titled solely in the US including Puerto Rico. Dealers sometimes opt to take ownership of a vehicle and are required to in the following states: Maine, Massachusetts, New Jersey, Ohio, Oklahoma, Pennsylvania and South Dakota. Please consider this as you review a vehicle's estimated ownership history.

Title Issued

A state issues a title to provide a vehicle owner with proof of ownership. Each title has a unique number. Each title or registration record on a CARFAX report does not necessarily indicate a change in ownership. In Canada, a registration and bill of sale are used as proof of ownership.

Follow Us:  facebook.com/CARFAX  [@CARFAXinc](https://twitter.com/CARFAXinc)  About CARFAX

CARFAX DEPENDS ON ITS SOURCES FOR THE ACCURACY AND RELIABILITY OF ITS INFORMATION. THEREFORE, NO RESPONSIBILITY IS ASSUMED BY CARFAX OR ITS AGENTS FOR ERRORS OR OMISSIONS IN THIS REPORT. CARFAX FURTHER EXPRESSLY DISCLAIMS ALL WARRANTIES, EXPRESS OR IMPLIED, INCLUDING ANY IMPLIED WARRANTIES OF MERCHANTABILITY OR FITNESS FOR A PARTICULAR PURPOSE.

© 2025 CARFAX, Inc., part of S&P Global. All rights reserved.
3/22/25 6:08:32 PM (CDT)

I have reviewed and received a copy of the CARFAX Vehicle History Report for this 2019 MERCEDES-BENZ C-CLASS vehicle (VIN: 55SWF8EB9KU289674), which is based on information supplied to CARFAX and available as of 3/22/25 at 7:08 PM (EDT).

Customer Signature

Date

Dealer Signature

Date